

PNEUMATIC ACTIONS



201 WEST 11th STREET, CHICAGO, ILL.

KIMBALL ORGANS

from Technical standpoint

KIMBALL ORGANS

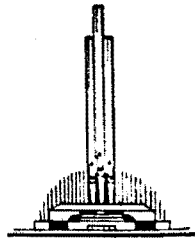

*from a
Technical Standpoint*

This book is dedicated to those whose interest in the installation of an organ lies beyond the console—and whose desire to purchase only the finest prompts investigation of the instrument, part by part.

W. W. KIMBALL COMPANY

ESTABLISHED 1857

ORGAN BUILDERS

FACTORY AND EXECUTIVE OFFICES

CHICAGO, ILL., U. S. A.

A Glance Into The Past

TRADITION and mythology are the only records of the time when man first discovered the musical possibilities of blowing a whistle. Few of the arts and crafts date back even to that much later day when men began to assemble a number of whistles under the control of one performer into something like the organ of today. For centuries after that time the organ builder was a craftsman, who built organs just as carpenters build houses today. He brought his tools and his skill to the job and his work was done under the eye of his employer. Organ builders probably differed in ability and character just as they do now, but in that era of hand work, performed under the employer's eye, there was little need of formal contracts. The organ buyer hired an organ builder as he would hire any other craftsman—AND HE WATCHED THE WORK.

The Factory Invades an Ancient Art

A long time after, not many decades ago in fact, organs shared the results of the discovery that any work could be done better and more economically in one place, with the aid of machinery and power. This altered the old relation between the organ builder and his employer. Now the builder did all his work in the factory and delivered the finished instrument. Possibly the employer—now the buyer—could accept or reject the finished product, but he could no longer watch the actual materials or work. Still the old traditions lived on for a while, and much of the early factory work was executed as carefully and honorably as if it were still done under the eye of the employer. There was a new need for trust that the artist would really perform his undertaking in the far-off factory as faithfully as before, but this trust was generally deserved and freely given. The old traditions were still binding.

A New Competition Appears

As science and invention gave new tools to honest industry, they likewise gave new oppor-

tunities to the shrewd producer of shoddy imitations of the products of good craftsmen. Organs were no exception, as anyone familiar with recent organ building will testify. The ethics of the wooden nutmeg and the "pure fruit" jam of synthetic origin, invaded the organ industry. For obvious reasons, the organ builders who still maintained the old standards had to suffer this sort of competition, largely in silence, trusting to the buyer's good judgment to look very carefully before he leaped.

An Old Firm Meets the New Conditions

For more than an ordinary lifetime, the W. W. Kimball Company has been building organs and seeking employment to do so along traditional lines. It asked and obtained the buyer's trust because it deserved this trust. Purely on this basis it built and delivered many millions of dollars worth of its organs, but it was becoming steadily more evident that under modern conditions the buyer needed something like the old ability to watch the work, in order to aid him in discriminating between what was fine and what was shoddy. So this old concern decided to take a step hitherto unknown in organ building.

Henceforth it will continue to seek employment as an organ builder on a basis of trust—but now on a basis of trust founded on complete frankness. So far as Kimball is concerned, both buyer and seller are going to know exactly what each is to give and what each is to receive. The agreement between them is to be so clear and binding, that it will serve just as the ability to watch the actual work, served the old time organ buyer. This policy agrees with present trends in other lines. Jewelry is stamped, solid or plated, food packages bear labels which Federal law decrees must truthfully describe their contents. Extravagant claims are common in selling and in some forms of advertising, but the tendency is toward a frank and exact statement of what the buyer will get if he buys, and toward

sufficient explanation so that the buyer can know whether what is promised is, in fact, what he wants.

It was simple to put this policy into force. Since the buyer could no longer watch the materials going into his organ, W. W. Kimball Company decided to add a section to its contract listing every material and design which it would use if entrusted with the contract. Since workmanship and tone quality could hardly be described in enforceable legal terms, it would guarantee the results. Anyone familiar with contracts will see instantly that these two things have been done, in the most binding terms possible.

Still it would be of little advantage to the prospective buyer of an organ to know in fullest detail just what he would get, unless he was also sufficiently informed to judge correctly whether what was promised was what he wanted to buy. Many buyers are so informed; others, because of little previous contact with organs, need some explanation, as well as information.

In addition to its revolutionary contract, the W. W. Kimball Company has prepared this book which takes up the promises made in the contract and describes what is promised, explains why it was chosen and what the result will be when the promises are carried out in a Kimball Organ. It is hoped that this absolute frankness will be pleasantly welcome to those who are qualified by experience to judge, and that it will be a great help to those who, for the first time, find themselves confronted with the problem of buying an organ.

The Kimball "Structural Details"

This section of the Kimball Organ Contract will repay the closest study by anyone interested in organs, and especially in the purchase of an organ. Part by part, from the console to the pipes, it lists the specific materials and designs which are used in all Kimball Organs. If the reader desires to do so, it is easy to check these provisions, point by point, with the explanation, which is the purpose of this book.

The Kimball Organ

How It Is Built---How It Works---Why It Is Best

LET us now, figuratively, go to a Kimball Organ and examine it part by part, in our effort to determine of what and how it is made, how it operates and why its makers know that each material and method chosen is best.

Our first glance will show that the instrument is made up of two main divisions. The first one we encounter is the Console or Keydesk. The other, generally completely concealed nowadays, is the Organ itself—its windchests with their supporting structure, its reservoirs, wind trunking, and its expression-controlling swell shutters. Examining these parts of the organ, we will naturally be interested in their materials, workmanship, finish and appearance.

In these divisions are the moving parts which together make up the "action" of the organ. Here our examination must concern itself not only with the materials, workmanship and fin-

ish, but also with the vitally important matter of designs which will permit the moving parts to perform their functions with accuracy, swiftness, quietness and freedom from any excessive effort or strain which would lead to early trouble.

Finally, we come to the pipes, which are the ultimate reason for all this structure and mechanism. Here we find the most modern development of an ancient art; an art which enlists every resource of the physical sciences and demands a complete knowledge of acoustics and sound. The educated hand and eye and the trained hearing of the voicer can never be displaced by machines or mechanical processes if the organ is to be a true work of art.

We shall want to look carefully into tone production, the making of pipes and the materials used, the determination of scales and voicing treatment. We shall wish to make sure that, as

the organ is finished, so it will stand, without deterioration of tone from sagging, crumbling, chemical action, broken tuners, splitting, warping, loosening of stoppers or other preventable causes. Recognizing to the full the importance of design, materials and skill in building an organ action that will be fast and reliable and give the pipes their chance to speak promptly and properly, all this accomplishment is in vain if the pipes themselves are lacking in musical

qualities, are slow in speech, have not the individual characteristics desired, or do not blend into a balanced ensemble. So we quite properly insist upon prying into the conditions under which the voicers do their work, and learning how they produce musical sounds from the toneless pipes they receive.

Having now clearly in mind the general purposes of our examination of the various parts, let us tackle the most obvious part first:

The Console

WHERE we are looking at a part of the organ, sometimes concealed but often very important in the decorative treatment of the auditorium in which it is located. Since we are examining a Kimball Organ, we find that the console is a well executed example of the cabinetmaker's art, built of whatever native cabinet wood best harmonizes with the environment, and well finished inside and out.

Since it is also the organist's point of contact with and means of control of the tonal resources, we should note what has been done to aid him. We find the keys surfaced with genuine ivory and ebony, because these materials have never been imitated successfully in either durability or "feel" by any of the numerous substitutes in use. We find the pedal keys surfaced with removable hard maple faces, so that when worn, these faces can be replaced without the need of installing new keys. We find both manual and pedal keys hinged and removable for easy access to contacts and regulating devices. Playing controls are so located that, even in a five manual organ, all keys and pedals can be reached without loss of balance. Since organists have never been able to agree on the type of stop control, the console we are examining may have stop keys set in one or two rows above the top manual. It may have stop keys set in rows in stop jambs at the sides of the keys, or it may have draw knobs set in vertical rows in stop jambs in a similar position and have tilting tablets for couplers. Kimball Organs are made with all these accepted types of control as desired. If stop keys are chosen, we find each one set in a metal frame containing the spring and adjusting

screw and removable as a unit. If draw knobs are preferred, they move in and out in a straight line in velvet bushings. In either case the motion is assisted by a toggle spring, so that a touch will start them and the spring will complete the motion on or off. All other controls, such as combination pistons, toe pistons and swell pedal assemblies are mounted in self contained removable units so that inspection and adjustment are easy. The swell pedals are mounted on a hardened steel shaft and turn in bronze bushings with independent tension adjustment. These bearings are lubricated from the outside by ball cup oilers set in the face of the pedal, so that wear is negligible and squeaks are easily kept out. This mounting is in sharp contrast to the screen door hinges or wood on metal bearings generally used. For permanent appearance and wear, all exposed metal fittings are heavily plated with non-corrosive metal. For permanent ease of reading stop names, all stop controls are hand engraved and the color is inlaid in the engraving. Indicators are provided for all blind movements. Mice and rats cannot enter the console. All openings are closed off. All felt is poisoned against insects.

The adjustable combination action combines the advantages of the best types met with elsewhere. It is set *either* by arranging the stops, pushing the setter piston and then the desired combination piston, *or* by holding in the desired combination piston and moving the stop or stops to be changed. It is simple, quick and quiet; it cannot get out of order; and it possesses important advantages in dealing with couplers and the pedal organ. The setter piston can be locked.

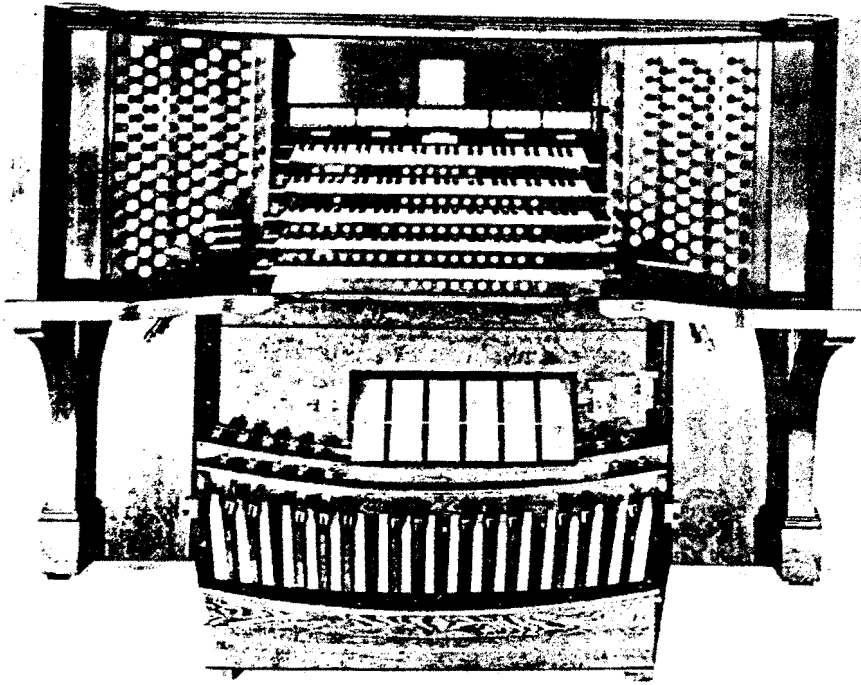

In this conventional English type of console the speaking stops are operated by ivory draw knobs, the couplers by ivory tilting tablets. The Kimball selective expression controls and indicators are located just above the couplers. The convenient inclined keyboards of the five manuals are clearly shown, as are the hinged feature of the removable pedal board. The cover rolls down. Bench and music rack are not shown.

A three manual roll top console, with all speaking stops, couplers and tremolos controlled by stop keys; otherwise similar in conveniences and operation to the one shown above. The most compact form of all. The cases of all these consoles may be worked out in Gothic or other styles, to agree with their surroundings, and in any wood and finish.

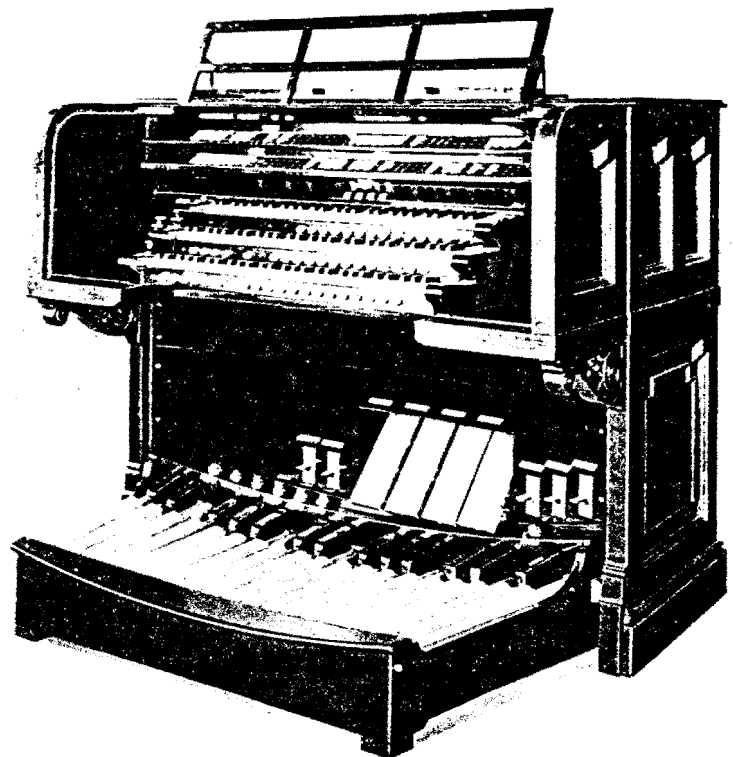

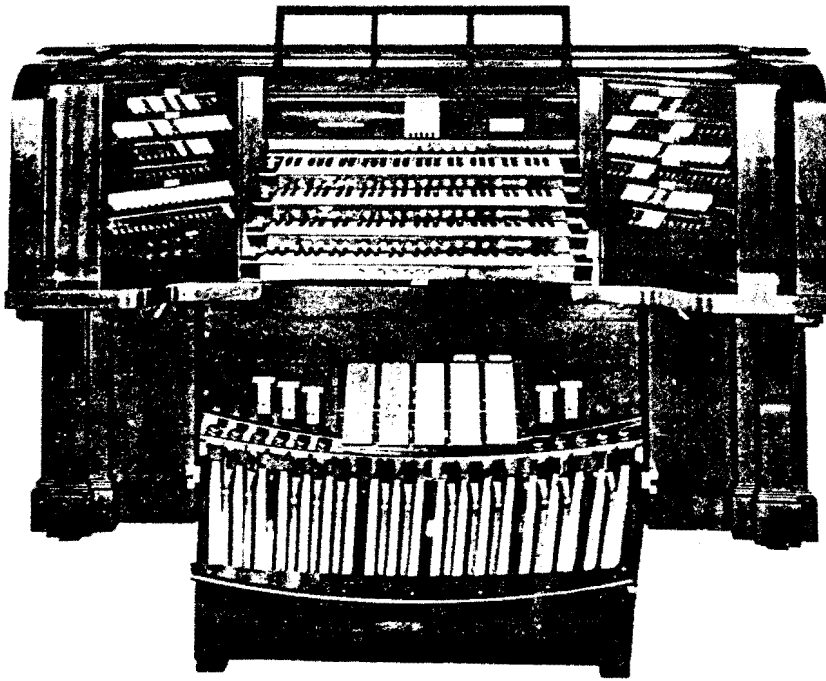

This four-manual console has stop keys in vertical jamba, making possible a smaller console than when draw knobs are used. Another convenience is the Kimball selective swell control, which here operates six expression chambers from four expression pedals, in any desired combination.

PHOTO SHOWS ACCESSIBILITY OF KIMBALL CONSOLE

- (a) Stop key bolsters with combination action, raised.
- (b) Top and music rack lift up.
- (c) Keys hinged for access to contacts, key springs and regulating buttons.
- (d) Combination piston assembly removable in unit.
- (e) Knee panel removable in unit with expression pedal assembly.
- (f) Mouse and rat proof covers to all openings into console interior.
- (g) Stitches and pneumatic single removable units.
- (h) Toe pistons removable units.
- (i) Pedal board removable.
- (j) Pedal board hinged on metal transom so as to be raised without removal.

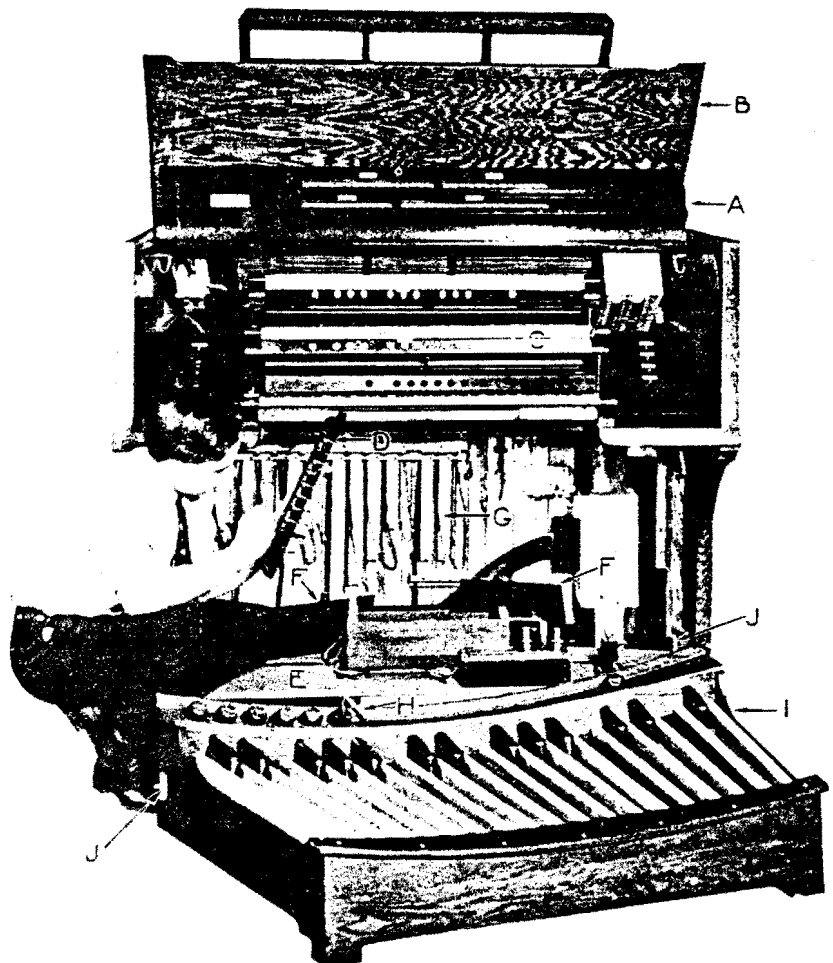

The Organ

TURNING now to the other main division, we examine the general structure for character of material and finish. We find three woods used. The chests, reservoirs, windtrunks, etc., are made of No. 1 clear white pine. This wood, due to resinous oils, has the characteristic of permanent resistance to warping or splitting from atmospheric changes. Together with clear, hard maple, it has always been the "hallmark" of quality organs. In the supporting structure we note the sound, clear Douglas fir. These tough, strong woods offer both efficiency and economy for the purposes. All this woodwork is completely sealed from air by two coats of lacquer. Kimball Organs pioneered in bringing the advantages of this tougher, more elastic finish from autos to organs. The fact that this lacquer finish has supplanted former varnish jobs in automobile finishing, where the service is so much more severe, makes it interesting to find here. Varnish is used, however, to seal the air passages bored through the wood, which is immersed in boiling hot varnish that penetrates and seals the pores. Its use only in borings eliminates any question of wear.

This material has some important functions to perform besides being the supporting structure of the pipes and action.

First, it must act as the means of conveying the compressed air to the points where it is needed. This compressed air originates in the blowing plant, and is delivered to the reservoirs in the organ through heavy galvanized iron pipes. The function of the reservoirs is to admit just as much air as the organ is using and to maintain this air supply at an absolutely even pressure. Instead

of the usual large single valve, we note that Kimball reservoirs are equipped with three valves of graduated sizes. The smallest is a hardwood cone valve which opens first. This valve is always working when the wind is on. As the rise and fall of the reservoir opens and closes it, just enough wind is admitted to offset the slight seepage of wind through the organ. The largest valve is of such dimensions that as much wind can enter through it as any possible requirement of playing can use. It comes into operation when a full organ chord makes a sudden heavy demand on the air supply. The other valve comes into operation between the first two and is of medium size. It admits air as required for ordinary *piano* and *mezzo forte* playing. In addition, it is so adjusted in size to the tremolo that it cannot admit air quite as fast as the periodic beats of the tremolo exhaust it, and thus the pressure varies slightly, which helps to impart the beautiful vibrato to the Kimball pipes. This equipment of three valves

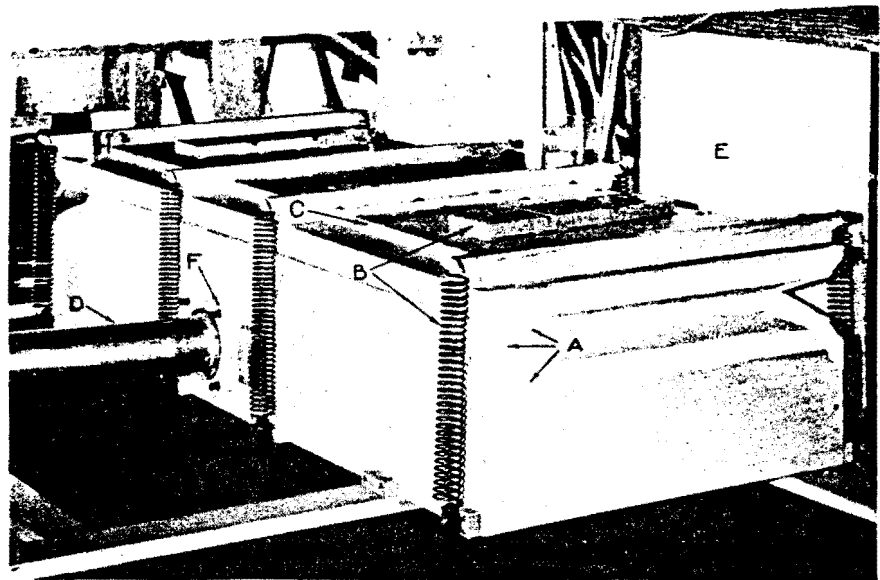

KIMBALL RESERVOIR

- (a) Heavy leather gussets and hinges—same construction duplicated inside of bellows.
- (b) Pressure from coiled springs and felt screwed-on weights.
- (c) Panels for easy access to interior.
- (d) Metal conductor with heavy zinc flange.
- (e) Large wood conductor.
- (f) Wood regulating gate for tremolo.

is rather costly, but, while the single valve could open far enough to admit sufficient air, provided it were large enough, this opening could occur only as the top of the reservoir which moves it is considerably displaced. There are considerable forces of wind pressure and momentum involved and the single valve does not supply wind enough, supply it quickly enough nor maintain a sufficiently uniform pressure for Kimball standards. When the reservoirs have performed their function of taking in wind and delivering it either with an absolutely steady pressure, or if the tremolo is operating, with a

gentle undulation in pressure, the next step is to deliver this regulated wind to the various pipes.

The distributing system is annealed zinc conductors carefully enameled for appearance and resistance to corrosion, fastened onto the wooden parts with flanges, screwed on. Flanges are packed with felt or leather gaskets. This contrasts favorably with the paper or fibre tubes often used, which are merely pushed into holes in the wood and glued there. The larger sizes of Kimball conductors are made of white pine, equipped with flexible joints so that any settling or shifting of the parts they connect cannot break or strain them. They are permanently attached with screwed-on hardwood flanges, packed with felt.

The tremolos are of the bellows type, made of white pine. This type has a truer undulating effect than any of the older "beater" types. Their speed is governed by adjustment of a weight, which acts like a pendulum as it is moved closer to or farther from the hinge. The intensity of beat is governed by a movable gate in the supply pipe.

So far in our examination of the organ we have noted a sturdy, well finished structure of materials as good as and no better than actually required. We have noted the unusual precautions to insure the absolute equality of pressure if the tremolo is not in use, and the desirable gentle undulation if it is. Such points as the paneled construction of the reservoir for easy access to the interior and exclusive use of fine alum tanned sheepskin both inside and out, instead of the cheaper rubber cloth sometimes used, are interesting. Much of what we have noted so far is about what we would expect in a fine organ, although the reservoirs have

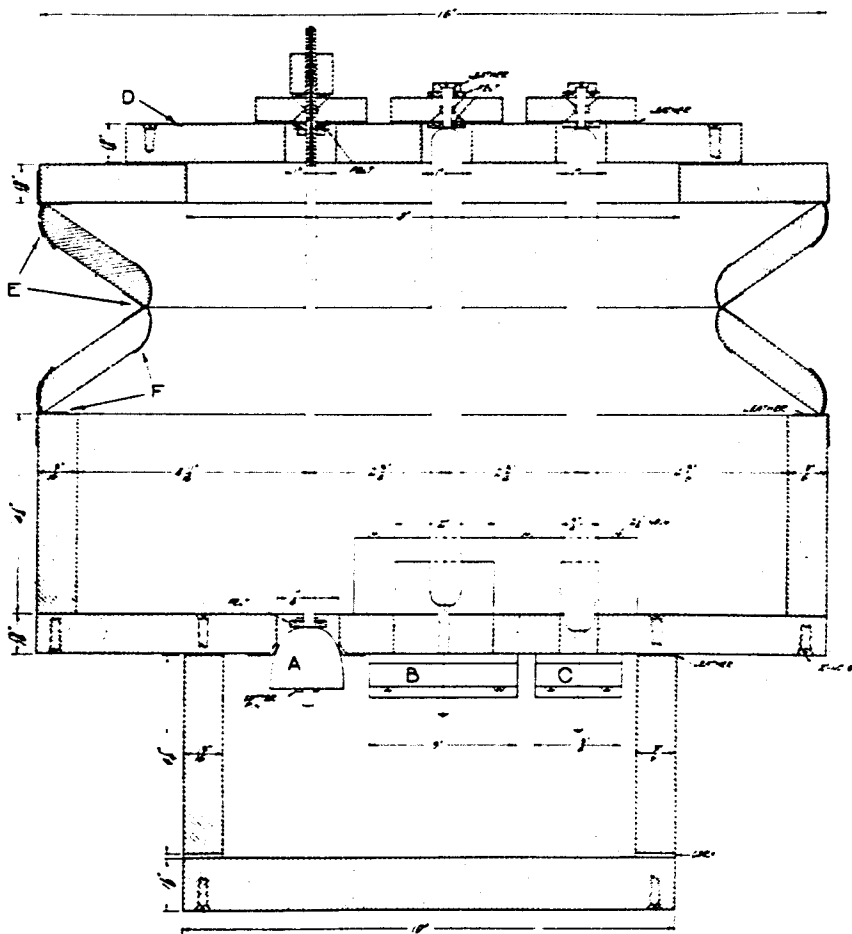

CROSS SECTION DRAWING OF RESERVOIR SHOWING THREE-
VALVE WIND CONTROL

- (a) Cone valve admitting enough wind to offset seepage of air.
- (b) Large valve to admit enough wind to maintain pressure against a sudden full organ chord.
- (c) Medium valve calibrated to admit wind required for mezzo-forte playing and for response to the tremolo.
- (d) Paneled top.
- (e) Outside leather hinges and gaskets.
- (f) Inside leather hinges.

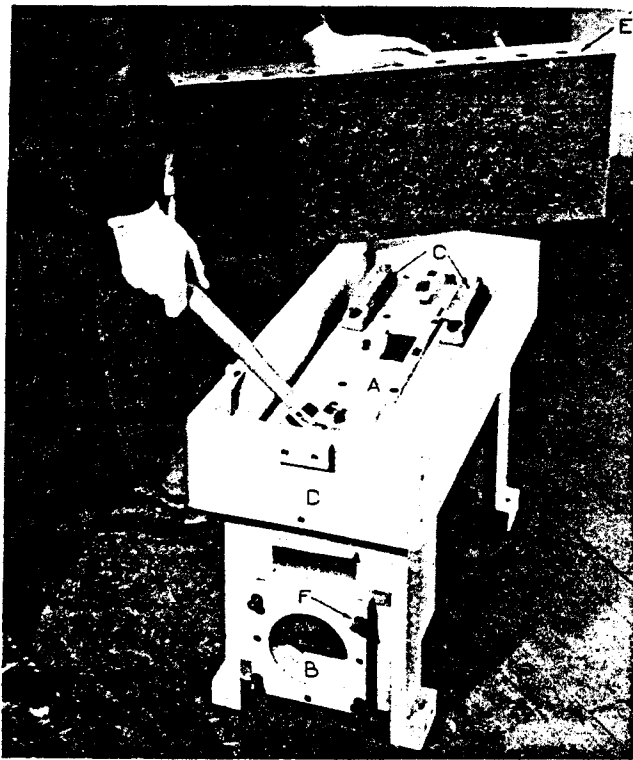

TREMOLO

- a) Double slide valves adjusting volume of air discharged by tremolo.
- b) Wind gate governing volume of air which enters tremolo.
- c) Adjustable felted weights which govern speed of beat.
- d) Heavy wood muffer box.
- e) Sound absorbent cover to muffer box.
- f) Tension spring and washers.

been unusual.

But now we notice the swell shades, which are so distinctive that we will want to be very sure of the reasons. We find that they are made of laminated

SWELL SHADES AND MOTORS

- (a) Shutters two or more inches thick — felted edges.
- (b) Note graduated width of shades.
- (c) Lubricating points for bearings.
- (d) Individual motor and spring for each shutter.
- (e) Felted muffer for swell front.

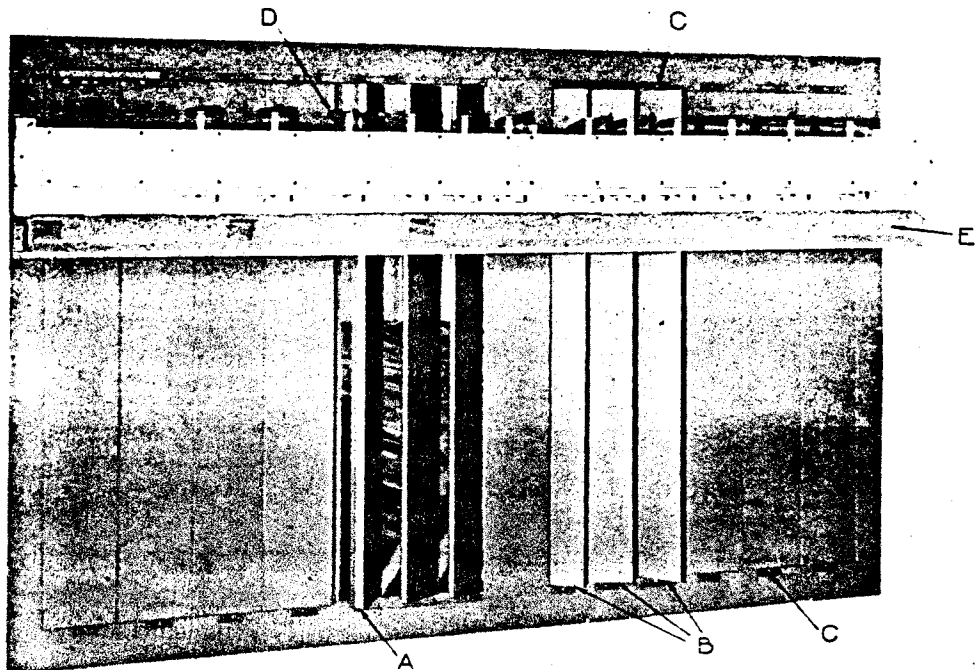

chestnut, two inches or more thick. Obviously the lamination is to prevent possible warping and sticking. Obviously, too, the unusual thickness is to secure the range of power which is so notable a feature of Kimball Organs. But we notice that the shutters are of graduated widths, beginning very narrow, with a steady increase in width. Unlike most shutters, they are not operated all together but are designed to open successively. Every organist remembers how, with the old mechanically operated swells, he had to start his crescendo very gently because the first opening released so much of the tone. By making the first shutter to open, quite small, and gradually increasing the size of the shutters in the order they operate, it has been found possible to obtain an electrically controlled crescendo fully as smooth, gradual and responsive as the old mechanically operated swell gave when properly handled. But sometimes we do not want a smooth, gradual crescendo—just the contrary indeed, if we are after an accent. Here again this marvelous device proves superior. A full front of heavy shutters weighs hundreds of pounds. To move it all suddenly requires a powerful and often noisy machine. Once started, it is not easily stopped. With the individual, unconnected, non-binding shutters we are examining, each shutter is equipped with its

own motor, which is graduated in size as the shutter itself is. The motor is just strong enough to move the shutter quickly. Each motor and shutter does exactly the same work in the same way. whether they come on in slow succession to make a smooth, gradual crescendo, or all at once to make the sharpest accent. There is no more force required, or momentum to absorb without noise, one way than the other. In relative quickness of response, this individual shutter action compares to any single engine type about as a string of electric cars, each with its own power, compares to a freight train, pulled by

one engine. Every organist makes some remarks—audible or silent—on the subject of squeaking swell shades. Here we note that the shades move on a hardened steel surface and in wooden bearings which have been boiled in oil. Squeaks are improbable and easily removed. So all in all, our examination of the organ structure has shown us, as we would expect, the usual high grade materials and construction typical of quality organs, and the unusual features of the more durable lacquer finish, the three-valve reservoirs and the superior shutter system.

The Action

BY the term "action," organ builders mean that train of operations starting at the key and ending at the valve under the pipe, through which the organist controls the tonal resources of his instrument. Certainly we are going to demand two things of this train of mechanism. **IT MUST BE RELIABLE AND IT MUST BE RESPONSIVE.**

Like most other modern actions, the Kimball action is electric, or, more properly, electro-pneumatic. Electricity is used to transmit the impulses, which it does with the speed of light, more than 180,000 miles per second. Compressed air, necessarily present to blow the pipes, is used for power. It is not desirable to use elec-

tricity for power, having compressed air available, because sufficient current for power purposes would burn the contacts rapidly. It is not desirable to carry the transmission of impulses part way by means of electricity and then turn this electric impulse into some train of mechanical devices. The ideal is to get the speed of electricity right up to the point where power is needed and then to use the force of the compressed air. Let us in imagination press a key, and, as we follow the train of operations through the action until the pipe sounds, we can study the materials and methods used and the reasons which guided their selection.

Contacts

IN pressing an organ key we are doing about the same thing as we do in ringing a doorbell. We are closing an electric circuit which terminates in a magnet. The main difference is that the button only rings a single bell. The organ key, on the other hand, has to play a great number of pipes, or any combination of pipes made possible by the coupler system, and therefore it is necessary for the key to close a great number of circuits simultaneously. These contacts must be absolutely reliable and very durable. The number of operations of an organ key in a year's use is almost incredible.

The contacts must make circuit every time and the first time, even after long disuse. The problem then is to make them in such a way and of such a material that they will stay clean constantly and be durable. We find that the Kimball contacts cannot accumulate dirt because the two elements are of cylindrical shape and are set so that one element is at right angles to the other, thus securing always a *point* of contact on which dirt cannot lodge. In addition, the motion of the key causes a slight rubbing action between the two elements which aids in keeping them bright and polished. We find the contacts

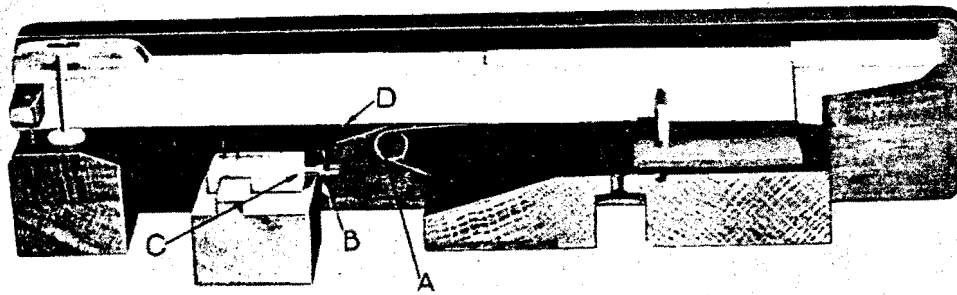

KEY AND CONTACTS

- (a) Spring located at position on key where it will keep the proper tension.
- (b) Contact plates faced with concave silver bar attached directly to key, eliminating all mechanical connections between key and silver contacts.
- (c) Silver contact wires in block located directly below key.
- (d) Regulating screw for contact plate.

durable for two reasons. They operate magnets which consume very little current (being wound for the high resistance of 400 ohms), the coils of which act as condensers to prevent any sparking. Twenty-seven of these magnets require but one ampere at 15 volts. No other organ magnets consume so little current. One other builder uses magnets wound to 240 ohms resistance. one uses magnets wound to 200 ohms and the rest average around 90 ohms. Naturally contacts are subject to burning in proportion to the quantity of current passing, and the resulting intensity of the spark when the contact breaks. Again, the contacts are durable because they are made of silver.

In determining the best material for this purpose, a test was run, using contacts of many designs and materials. This test, which mechanically reproduced the motion of the keys, extended over a period of six months, at the rate of 240 contacts per minute, 48 hours per week. The metals tested included three alloys of silver, two alloys of phosphor bronze, tungsten, platinum, German silver and others. Only platinum, tungsten and silver stood up under this test. Silver, the only metal obtainable in spring wire, was chosen. We know that metallic oxides are non-conductors of electricity, and that most metals oxidize rapidly at a point where a circuit

is being broken, thus soon coating the contacts with a layer of non-conducting oxide and causing dead notes. This is particularly true of phosphor bronze. Silver tarnishes, but the tarnish, a sulphide, is a good conductor of electricity.

The relative conductivity of metals in use today for organ contacts, as given in standard engineering tables ("Mechanical Engineers' Handbook," "Non-Ferrous

Metallurgy," "Handbook for Electrical Engineers," etc.), works out at: silver, 100; (copper, 77.43), phosphor bronze, 10.77. Further indicating the eligibility of silver, from the standpoint of low resistance, we have: silver, 1.47 (copper, 1.589); phosphor bronze, 7.75.* Copper and the alloys in which it predominates, while good conductors for the flow of electric current, are notoriously bad as contact metals.

It will be of interest to note that gold and platinum, believed by many to possess superior characteristics, show on the same scales conductivities of 55.19 and 12.91 respectively, while brass is extremely low at 17.034—though all these metals make a better showing than phosphor bronze. Inversely, the resistances are: gold, 2.20; brass, 3.64; platinum, 31.8; and German silver, 38.4. Platinum, having the highest melting point, was once regarded as ideal, tiny bits being soldered to other metals to take the destructive spark in the early days of electric organ actions when magnets consumed so much current. Brass and German silver (which contains no silver) were then the alternatives in low priced organs.

Thus we see that in design and materials, Kimball contacts, like Kimball magnets, are as near trouble-proof as science and experience can make them.

Wiring

FROM the contacts the current flows into the cables, and through them to the magnets. Hundreds, often thousands, of wires are contained in these cables. Every wire is soldered at both ends. One wire may be carrying the current which is to actuate a pedal pipe, the next may be attached to a swell shutter. Obviously short circuits, from dampness or defective insulation, would be disastrous musically, in addition to the danger of fire. Here again we see evidence of thought and precaution, unknown in any other organ. These cables are machine spun. They are soaked in paraffin, are wound in many wrappings of paraffined paper, so that water cannot affect them, are encased in an outer covering which is impregnated with a flame-proof slate compound, and each wire in the main cables is individually insulated with nine coats of baked enamel, under the paraffined cotton insulation. They are very expensive compared to the usual cable, which is just the required number of cotton covered wires wrapped up in friction tape, but short circuits are impossible. Kimball cables comply with the Code of The National Board of Fire Underwriters, which even permits their installation without conduit, so safe are they from electrical or fire hazard. For protection against mechanical injury, however, such as sawing or nailing when making building alterations, all wiring should be run in conduit.

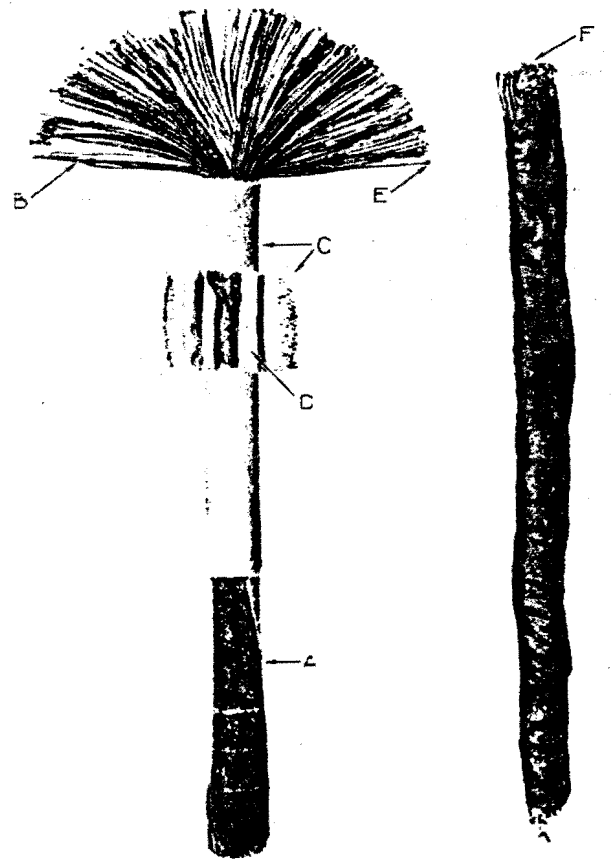

CABLES

- (a) Note exact laying of wires.
- (b) Note color code in wires.
- (c) Flame proof woven covering.
- (d) Layers of waxed paper.
- (e) Cotton insulation over tinned and enameled wires.
- (f) Ordinary taped cable from (—) organ, replaced by Kimball.

Magnets

THE final device in the electrical part of the action is the magnet. Its function is to transform the incoming electric impulse into a puff of compressed air which can be stepped up in power to whatever strength is required. This it does by lifting an armature which opens an exhaust port, starting the train of pneumatic mechanism.

In our examination we cannot see all the electrical details of the magnet structure and we cannot duplicate all the experiment and

study which guided its development. But we can examine some of the points of excellence that are plainly visible. We note that the coils are of No. 40 enameled wire and that this fine wire is soldered onto stranded terminals, where it leaves the coils. Thus the fine wire is exposed to no possible strain and breakage, eliminating a very frequent source of dead notes found in some other organs. We note that the air ports are screened, and we wonder why this simple precaution against the entrance of dirt has not

been used in other organ magnets, until we consider the enormous number of magnets used in a year's production of organs and the consequent cost of this little extra thought. We note that the base contains no wooden or soft metal parts, being die-cast, in one single piece, from aluminum. There is thus no chance for air to leak out and set the succeeding mechanism in action, which, together with dirt preventing the valve from seating airtight, is the common cause of "ciphers." We remove the bakelite cap. If it is tight we try a penny in the slot of the cap and find it serves as a screw driver. An odd instance of the thought used throughout. It was remembered that the organ man might not have so large a sum as a nickel or a dime, but it was hoped that he would always have a penny, so the slot was made to correspond exactly with the outline of a penny, which will always serve perfectly as a screw driver. The cap, when removed, shows a smooth, sharp edge on which the valve, or armature, rests. If fine dirt should get by the screen, it cannot stay on this edge and by preventing the seating of the armature, cause a "cipher." The armature turns out to be a sim-

ple disc of soft iron, purposely bare of any packing material, and copper plated to prevent rust. This means that it must seat perfectly airtight without any packing and that the entire assembly must be microscopically accurate. This is much more expensive than to make the assembly fairly accurate and rely on packing, but it is permanent, which can hardly be said of the attempt to stick discs of packing material to the iron armatures. Coupled with the electrical efficiency and economy previously noted, this mechanical excellence seems to imply a very superior magnet which is permanently reliable. In fact, we note that there is no means whatever provided for adjustment—*none being needed.*

This covers the electrical part of the action. We have noted the precautions taken to guard against burning or failure of the contacts, to guard against short circuiting of the electrical impulse in the cables, and to see that its work is done through a really efficient mechanism when it reaches the magnet. No electrical system in any organ approaches the efficiency of the one we have been studying, as competitive examination will show.

Pneumatic System

WHEN the electric impulse arrives at the magnet the action becomes pneumatic, the succeeding functions being operated by compressed air controlled by valves, of which the magnet armature is the first. This operates a small pneumatic bellows called the primary, about one inch square, which moves a two-way valve. The primary valve in turn operates the valves under the pipes.

In order to take the electric impulse as close as possible to the pipe valve, no primary operates more than seven pipe valves, so the air channel from primary to pipe valve can hardly be longer than about three feet. No mechanical device intervenes and no pipes are "tubed off" from the main chests. There can be no appreciable lag from some mechanism or long travel of air, after the electrical impulse has arrived.

The armature, which at the same time is the

first valve in the action, is only .020 in. thick, weighs 1.73 oz., and moves but .020 in. The primary valve assembly weighs 1.4 oz. The average weight of the pipe valves is 1.10 oz. The largest of them does not have a greater motion than 3.8 in., and few move 1.4 in. In fact, the entire assembly of moving parts in the largest Kimball manual windchest operated in one train weighs less than one ounce.

If it is important in an automobile to make the pistons of aluminum, even when moved by the explosive power of gasoline, to keep moving parts light, it is much more important in an organ action, where the power is so small and any lagging would blur the clearness of the organist's performance.

The impulse has now arrived at the pipe valve and we will want to look closely at this assembly, for now we are getting close to the pipes and

what we find here greatly affects their speech and tone. We note that the valve floats on the center of a round disc of soft English tanned pneumatic leather and thus moves absolutely without friction. It is located directly under the pipe foot so that the air travels the shortest possible distance from valve to pipe. The pipe hole is counterbored, so as to be considerably larger at the point of entrance of air than at the point of exit into the pipe. This insures that a supply of air larger than the pipe can possibly use is instantly released, and the shape of the boring acts like a steam injector to increase the velocity with which it enters the pipe. We see that by this additional precaution all the preceding costly effort to get the impulse to the pipe instantly is not neutralized by choking or long travel of the air from the pipe valve to the pipe. No Kimball pipe is ever "grooved," "ditched" or set otherwise than directly over its valve.

But we remember that there are stops as well as keys, and it is important that they work accurately and promptly as well as that the keys do so. It is still common to divide chests into compartments by partitions under each set of pipes. These individual compartments can then be supplied with compressed air or deprived of such supply by opening or closing large ventils. These compartments contain about 2.3 cubic feet of space, and to fill or empty them suddenly is a problem, not to mention the noise. In the organ we are examining this is not even attempted. The wind is never cut off from the windchests. The stop control is through pitman valves, one in each note channel of each set. These pitmans work in unison with the stop and shut off or open the channels between the primary valves and the pipe valves of the individual sets. In this system the amount of air required to operate a set of pitman valves is .0652 of a cubic foot. This is done with key-speed rapidity and complete quiet. These valves are discs of suede leather guided by beech tails. Tails, guides *and seats* are all graphited and burnished, so that sticking is impossible.

So far we have examined what is merely machinery and structure. No question of art

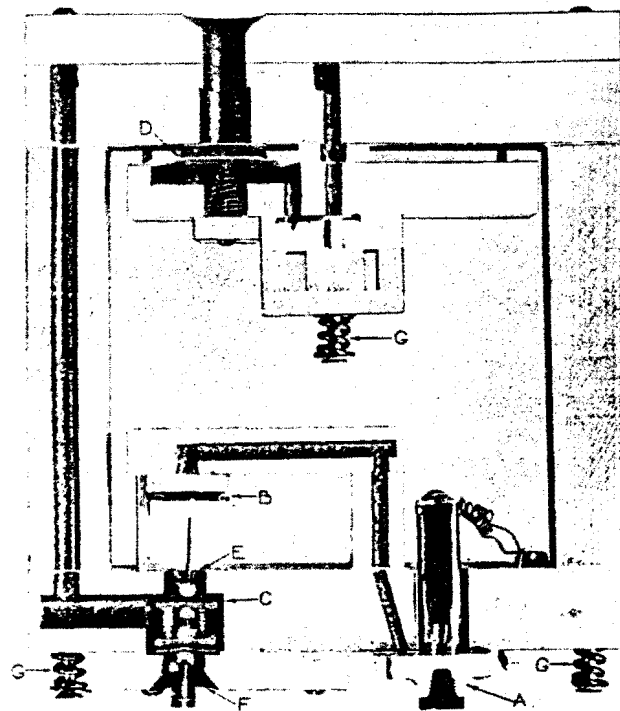

CONSTRUCTION OF WIND CHEST

- (a) Magnet.
- (b) Primary pneumatic.
- (c) Primary valve.
- (d) Diaphragm and valve.
- (e) Wind supply boring to diaphragm board.
- (f) Wind exhaust boring to diaphragm board.
- (g) Tension springs.

The pipes stand in two staggered rows, each pipe set in one of the countersunk holes directly over its valve (each hole is burned with a rotating burning iron to perfect smoothness, to fit the pipe toe), and are supported rigidly in a vertical position by the system of rack boards and standing racks, to the latter of which the larger pipes are booked or tied against fitted and felted supports.

has entered except as thought and experiment and willingness to spend necessary money have provided mechanism which is the connecting link between the organist's musical thought and its accurate expression in the resulting music. Now, having assured ourselves that this mechanism is adequate to, and in fact far superior to any other similar devices, we turn to the purpose of it all.

Pneumatic System

(Continued)

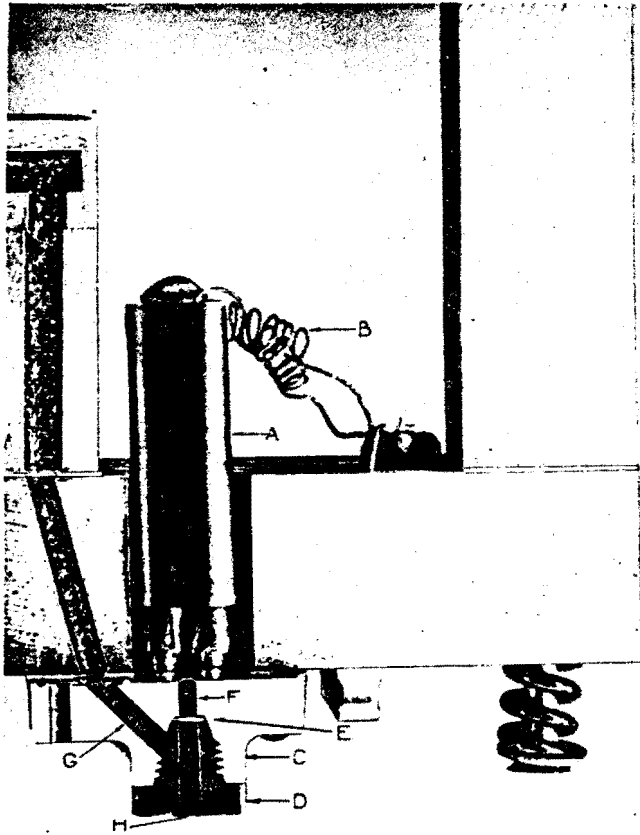

PRIMARY AND MAGNET

- (a) Winding of magnets.
- (b) Braided terminal wire.
- (c) Aluminum base.
- (d) Bakelite valve seat.
- (e) Armature.
- (f) Windway supplying wind to armature valve chamber.
- (g) Windway supplying wind from armature valve chamber to primary pneumatic.
- (h) Windway exhausting magnet from valve chamber.

VALVE AND PITMAN

- (a) Continuation of wind supply boring to diaphragm.
- (b) Wind chamber below diaphragm.
- (c) Diaphragm (leather).
- (d) Leather punching.
- (e) Soft felt punching.
- (f) Fibre disc.
- (g) Felt bumper.
- (h) Conical spring.
- (i) Windway to pipe.
- (j) Counter bore.
- (k) Pitman valve.
- (l) Pitman valve stem.
- (m) Pitman wind supply chamber.
- (n) Tension spring.

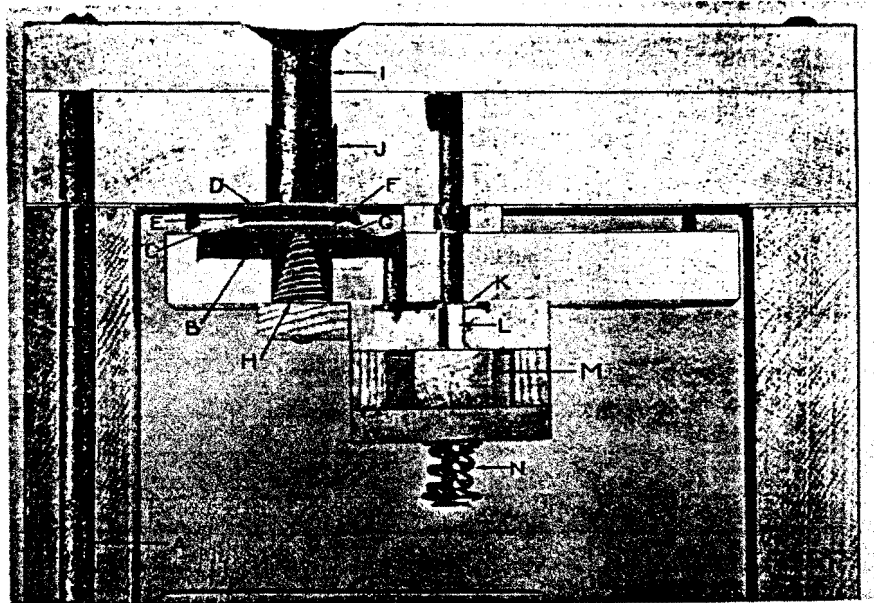

The Pipes

WE find the diapason pipes, the foundation of organ tone, made of heavy alloys of lead and tin (never under 25% tin) and nothing else, tin enough to give proper rigidity, no antimony to cause later crumbling, no coned pipes, no pipes with rolled tuners. We find that the diapasons are carried down into the big pipes of the lower octaves, many notes; sometimes an octave farther in cast metal than diapason pipes of other makes. Zinc must be used in some of the largest pipes because the alloys would crush of their own weight if carried too far into the bass, but the use of zinc is restricted to a minimum. The accompanying illustration will show what this means in size and weight and give some idea of the cost, a cost which is justified by the fine, firm tones, which hold their character clear down to the lowest notes. Like all Kimball metal pipes, these diapasons are never cut to length and tuned by coning, because that is sure to result in ultimate injury and loss of tone. They are never slotted and tuned by rolling down a strip of the metal, because this roll would be certain to break off with repeated bending and thus leave the pipes without any means of tuning. All are equipped with slide tuners which

cling tightly to the pipes and stay where set better than any other tuning device, and can be moved up or down indefinitely without injury to the pipes. In small pipes the slides are sprung on, in medium pipes they are taped on and in very large pipes they are clamped tight with a screw tension.

Open diapason pipes are designed to give loud, firm tones which combine pure fundamental with desired overtones. Their walls must be very firm and heavy so as not to vibrate sympathetically with the vibrations of the air column and thus impart undesirable harmonics. In string pipes the opposite is the case. These tones have little fundamental and are rich in harmonics. Here it is desirable to have a very light, hard pipe wall which can vibrate freely in sympathy with the air column and aid in developing harmonics. These pipes we find made of an alloy containing at least 45% tin, or often of so-called "pure tin" (90% tin, balance lead). Where a slot has been found helpful in building up string or horn tones, the metal is cut away, never turned down to form a tuning roll, which would be still more likely to break off because of the thin construction. They, too, have slide tuners.

"OPEN DIAPASON" 8' METAL"

Here is the actual size of the set of Kimball pipes listed in specifications under this name:

- (a) Bolted slide tuners on large pipes.
- (b) Taped slide tuners on medium pipes.
- (c) Slide tuners on small pipes.
- (d) Man with rule marked in feet for comparison with size of pipes.
- (e) Size of largest cast metal pipe in average scale Kimball diapasons, tenor C. (In some instances heavy cast metal is carried two to seven notes farther down the scale and matched to open wood pipes or extra heavy zinc.)

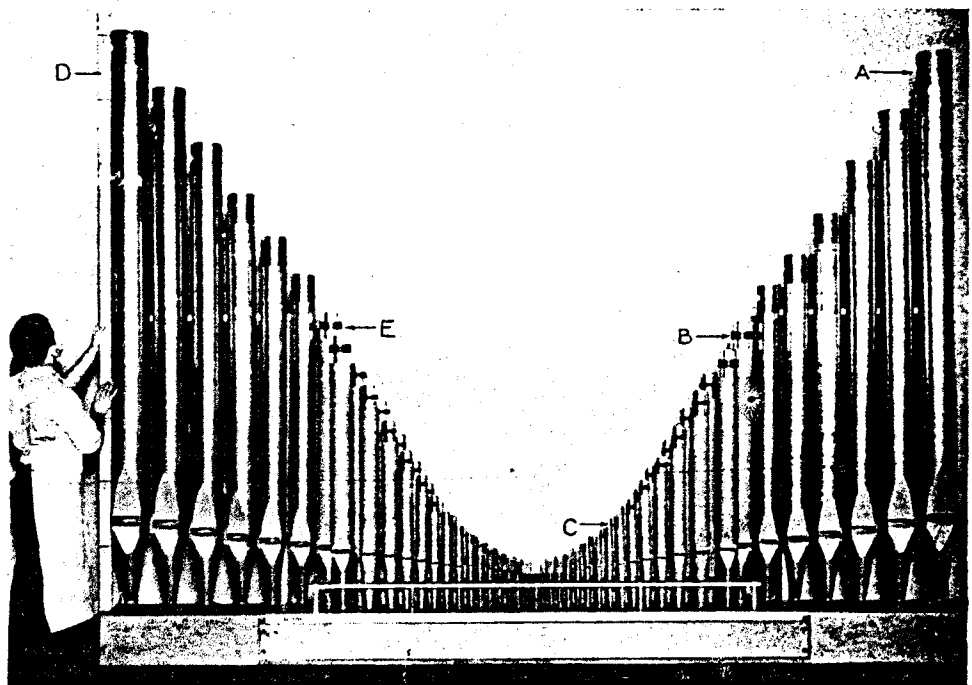

Flute pipes are found to be made of either metal or wood, according to the character of tone desired. Their common characteristic is the presence of few harmonics, over a strong fundamental tone. To sound well they must be of reasonably heavy construction, whether made of wood or metal, and their mouth parts must be very accurately and substantially made, so as to keep the adjustment given by the voicer. Flute pipes are generally made of spotted metal (45% tin, balance lead), occasionally of diapason metal (25% to 33 1-3% tin, balance lead) or of white pine with hardwood mouth parts, and hardwood fronts and backs in the pipes above two ft. C.

Reed pipes are imitative of the orchestral brass and wood wind instruments. Their tone is produced by the beating of a brass tongue, similar to the reed of a clarinet or saxophone. This vibration is amplified by the air column of the pipe, which acts as a resonator. The tonal outcome depends mainly on the formation of the tongue, the character of the eschallot and the material of the pipe. We find at least one-third of the area of Kimball reed pipes is heavy metal. The tongues are of heavy burnished brass. They beat against the eschallots, which in most cases are bored out of solid brass. They are secured in place by machined brass wedges instead of the usual wooden wedges. The tuning wire is heavy and it passes through an extra heavy block, which is cast with a shoulder that supports the

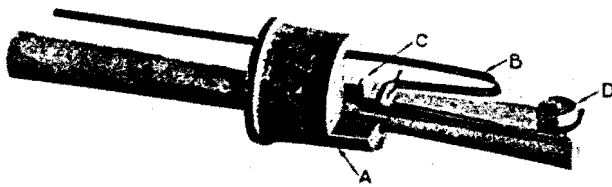

REED BLOCK ASSEMBLY

- (a) Note extra heavy block with shoulder.
- (b) Heavy tuning wire.
- (c) Brass wedge.
- (d) Reed weight screwed to tongue.

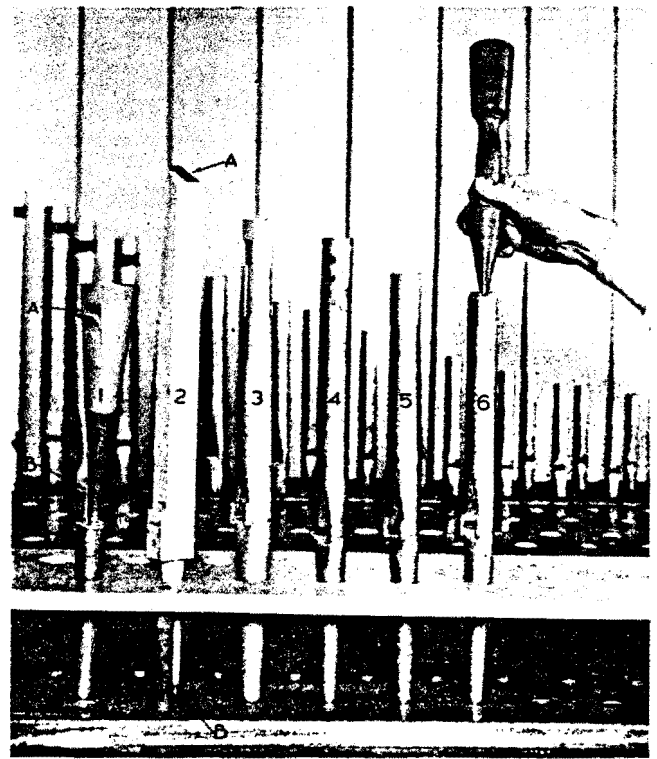

METHODS OF TUNING

- (1) Reed pipe.
 - (a) Tone regulating slot.
 - (b) Tuning wire.
- (2) Wood flute pipe.
 - (a) Tuning shade.
 - (b) Metal toe for regulating.
- (3) Slotted octave pipe with slide tuner.
- (4) Slotted octave pipe with roller tuner. Note liability of roll to break with repeated bending in tuning. Never permitted in Kimball Organ.
- (5) Diapason pipe with slide tuner.
- (6) Flue pipe. No means of tuning—must be conceded—note inevitable damage from repeated tuning. Never used in Kimball Organ.

eschallot against the pressure of the tuning wire. All these factors give such a rigidity and mechanical grip to the elements which must be moved in tuning the pipes and which the vibration is always trying to move out of place, that these Kimball reed pipes stand in tune as well as flue pipes. All these points of structure and material are important; indeed, they are quite costly compared to much that passes current in organ building, but they are vital because these pipes are the raw material on which the voicer's skill and taste is exercised and we remember that nothing executed in cheap, poor material is likely to be permanent or to satisfy. Now at last we come to the very heart of our investigation.

The Voicing

HERE we reflect that the organ under examination is just one of many and whether we like it or not, it belongs to someone else and we cannot buy it. What we want to get at is, first, have the voicers good pipes to work on? And, second, is their work done under conditions which insure a uniformly fine result? So we go to the Kimball factory and pry into every process and material involved in tone production.

With every order comes a full description of the auditorium, the size, the seating capacity, the type of service, or other use, the probable acoustical conditions. With all available information before him, the head voicer determines the scales of the pipes, the pressures to be used and general tonal treatment. Whenever possible, his decision is based on personal study of the building, but in any event it is guided by complete information and his experience with thousands of other organs. He is seldom confronted with a problem not previously encountered and solved and he knows how the former solution worked out. He then orders the pipes to be made up

in the pipe shop, being limited only by the standard materials and practices of the Company, which he helped to decide. When the pipes are done, he takes middle "C" of each set and balances these pipes till he has the combined tone which is to be the desired full organ tone of the completed instrument. In his hands is the individual characteristic tone of each stop and also their blending into a perfect ensemble. When he has each middle "C" to his satisfaction, both as an individual tone and as a part of the ensemble, he proceeds to set all the other "C" pipes of each octave to the same tone color and volume. That done, he turns the stop over to the assistant voicer who specializes in that class of tone, to fill in the other notes of the scale. All of these assistant voicers have been trained under him and each has specialized in some class of tone, as diapason, flute, string, orchestral reed or chorus reed. Each is thus qualified to carry through the outline of the tonal scheme entrusted to him by the head voicer. The voicers are under no compulsion to hurry their work. They work with the finest possible materials under the most favorable circumstances, and they know that their work must pass the inspection of the head voicer and superintendent.

By these means every detail of the tone is under the control of one man, and that man is qualified as few living men are, by ability and experience, to produce dependable tonal results of uniform quality, in any possible circumstances.

The best voicing would suffer from bad planting or crowding of pipes. Ideal speech is provided for in the Kimball windchest layout, and the pipes are so set that they cannot turn and shade each other. How different the situation, and naturally the results, where commercial conditions force the purchase of stops from stock pipe makers, and hasty work, necessary to keep within a competitive price.

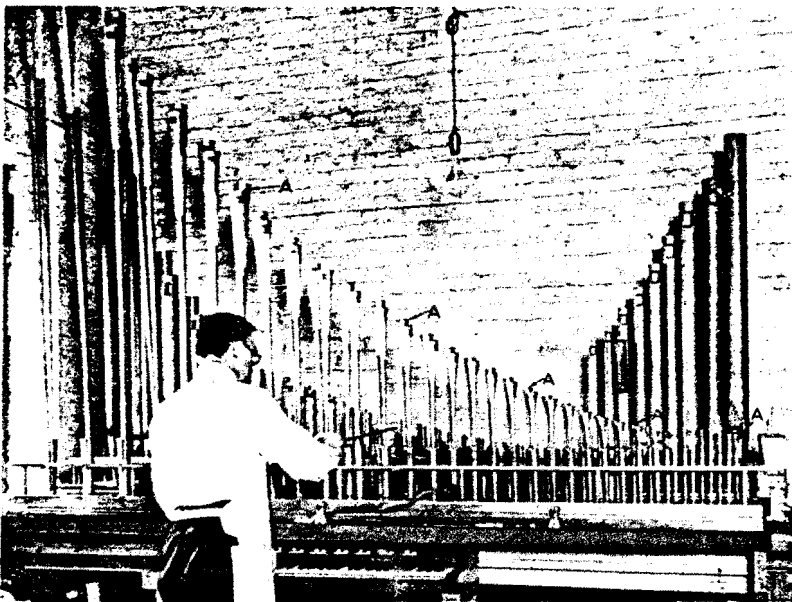

VOICING ROOM

Final inspection of set of Oboe pipes by head voicer:

(a) *Shows the "C" pipes originally voiced and regulated by head voicer before turning stop over to assistant voicer to fill in balance of stop.*

The Purchase

THE necessary act of purchase must be the signing of an organ contract. It is to the terms of this contract and their faithful execution unwatched by us, that we must look for our protection, in our purchase. So we finally turn again to the contract, and as it is a Kimball contract, we find precisely the assurances we desire, given by an organization of unquestioned financial strength and integrity. We find all the details we noticed in our examination of the console and organ, definitely covered.

We find exact electrical and mechanical specifications of all parts of the action fully given.

We find complete absence of such meaningless, ambiguous or deceptive expressions as "Swell shades to be of *ample* thickness," "The pipes to be of the *best and most approved* materials," "Console measurements to be the *correct standard*." In place of such expressions we find every material plainly specified, together with size, weight and formula, where such information is needed.

We find the exact details of the pipes, the formulae of the metals to be used, the portions of the stops to be of these metals and the portions to be made of zinc, all plainly stated.

We find the design of every part so described that from our examination we understand why these designs were chosen.

We find that while such matters as workmanship and tonal excellence cannot be legally defined and guaranteed in words, *the result, which is what we are concerned in, can be, and is.*

We find a positive assurance that every pipe in every Kimball organ is made in the Kimball factory.

We find the same positive assurance that every pipe is voiced by Kimball voicers, and for the organ of which it becomes a part.

We are promised that each Kimball organ shall

be completely erected, tested and tuned before shipment.

We are promised that each Kimball organ shall be installed by a trained Kimball expert, not by whatever local organ man happens to live nearest the point of delivery.

We are promised that the organ shall be installed to our complete satisfaction, as purchasers.

We are promised that tonally the organ shall be completely satisfactory to us, as purchasers.

We are promised that the makers will stand back of the organ in every respect—even tuning—for one full year after delivery, and will make any adjustments, repairs or replacements during that time without charge, except where such work is made necessary by damage to the organ from outside sources.

We can accept these promises without any reservation because they are given by a firm which has made and sold over a million organs and pianos during the past seventy odd years; carrying on its business under the same name, in the same place, and under the same family management. It has never experienced a failure, a reorganization, or a change of family ownership, and it has long enjoyed the highest possible financial rating.

We realize by this time that these promises are not irresponsible sales talk, nor are they merely high sounding phrases in sales letters. They are in the Kimball contract, and are as specific and legally binding as are the names of the stops to be supplied or the amounts of money to be paid.

Knowing all this, we can feel the same confidence in the outcome, even in spite of the fact that under modern factory conditions, we cannot watch the work, as did the organ buyer of long ago, when he watched each stick of lumber and pound of metal take shape under the hands of the old time craftsman.

The Test

WHEN an organ is finished, our interest in seeing it properly installed prompts the process which you see pictured below. The enclosing walls are outlined by strips fastened to the floor and the organ is erected as it will stand in the building for which it was ordered. Electrical and wind connections are made, and its own console—not merely a shop testing console—is connected with the very cables that will be used in the permanent installation.

After the mechanism has been tested in every respect, each key, stop and accessory found to work perfectly, the wind is weighed in the reser-

voirs. The pipe holes in the windchests are blown out (the reed pipe holes also dusted out with a feather) and the pipes are set in place.

Then come the head voicer and an assistant, who go over the regulation of the pipes and check up the general balance of tone. (The final "finishing" cannot be done until the organ is installed and subject to the acoustical conditions of its permanent home, and to its expression shutters—and then comes the most careful work of all.)

At last, another Kimball organ is ready for shipment to those whose possession of it will never cease to be a pleasure.

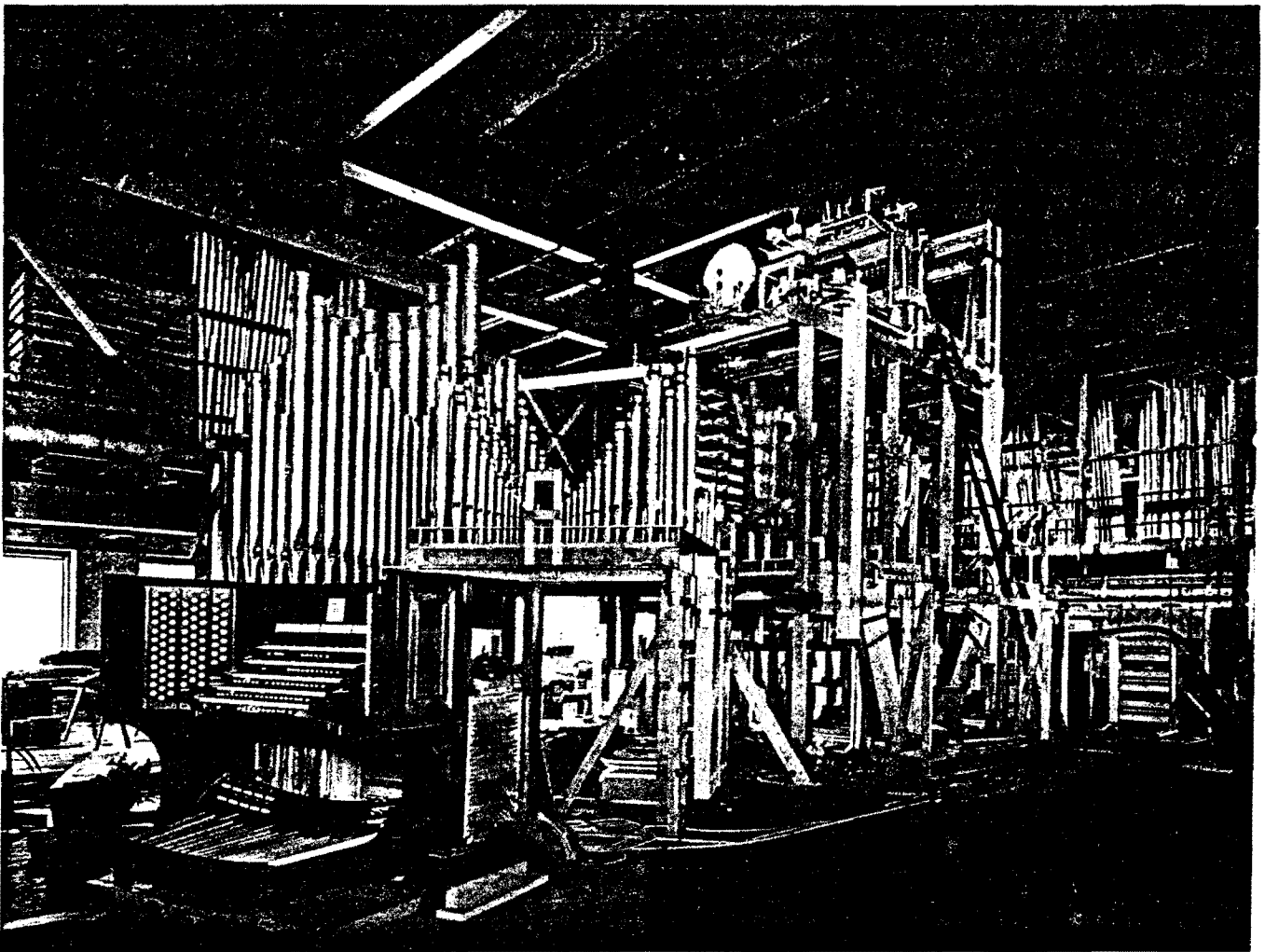

A CORNER OF THE LARGE ERECTING AND PROVING ROOM WHERE EVERY KIMBALL ORGAN IS COMPLETELY SET UP, TESTED AND PLAYED BEFORE SHIPPING.



KIMBALL HALL BUILDING
*Executive and General Offices
and Salesrooms*

KIMBALL ORGANS are the product of a factory "more than double the size and output of any similar institution." They share in the economy which results from the purchase of raw materials in great quantities, its delivery by rail and water direct to the plant, and the making of all component parts of organs, pianos and radios in one group of factories and under one operating expense, while they retain every advantage of independent management. Kimball Organs are built, not merely assembled, the company operating its own casting and pipe making plant—no necessity of buying pipes, voiced or unvoiced.

The technical and directing staff is composed of experienced men who are acknowledge leaders in their particular branches. The financial resources of the Company are of unquestioned extent and stability.

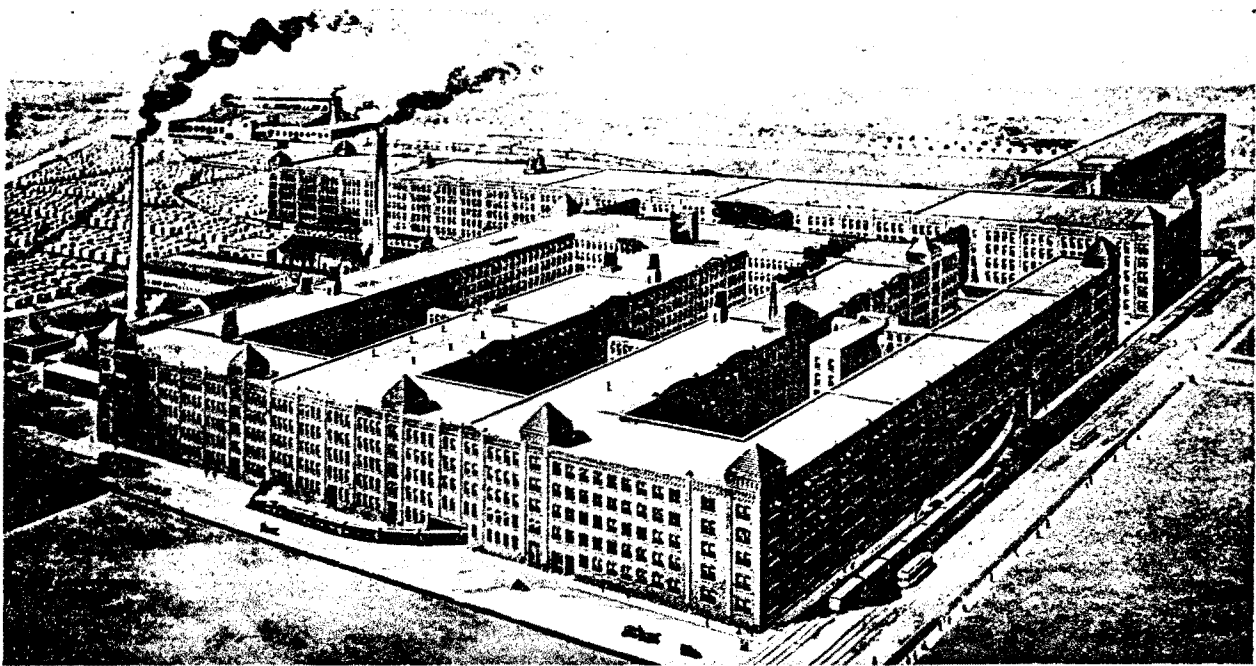

W. W. KIMBALL COMPANY FACTORIES, CHICAGO